

Virtual Workshop Offerings 2022

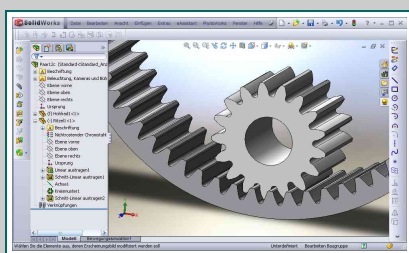
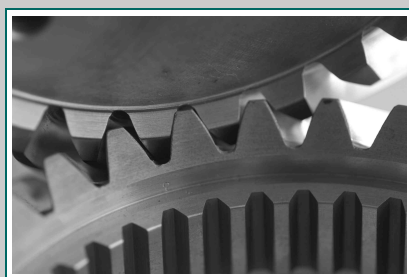
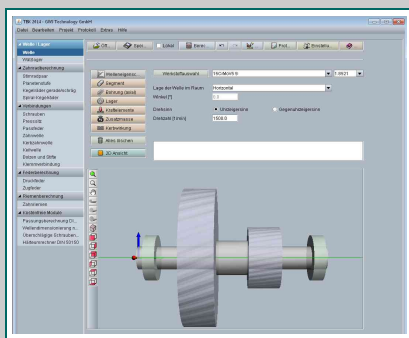
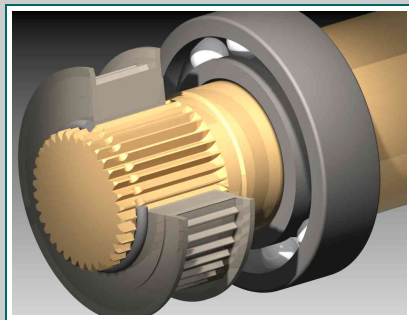
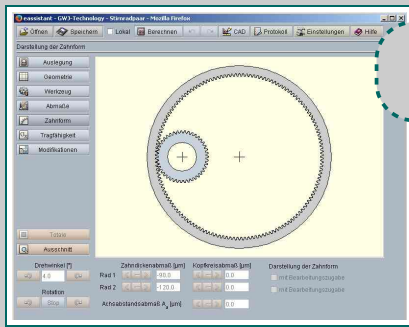

All workshops are run by our qualified engineers who have many years of experience in the field of mechanical engineering and development of calculation software. We are happy to have Mr. Dipl.-Ing. Gunther Weser on board. Mr. Weser has over 25 years of consulting experience and gives regular lectures for students at the Technical University Braunschweig in co-operation with the Institute for Engineering Design.

This year, all workshops will occur **online** via video conferencing platform. For the best learning experience and in order to provide a good balance between theory and practice, we recommend each attendee to use their own computer.

All workshops are live, not pre-recorded, to ensure that participants can ask their questions and have them answered by our highly-experienced trainers in real time. Your individual questions are welcome and our tips and tricks will help you to find the right solutions for your projects and to get the most of our software applications.

The participants use the calculation programs eAssistant and TBK 2014, SystemManager as well as GearEngineer/TBK Manufacturing Suite during the workshops. No special prior knowledge is required.

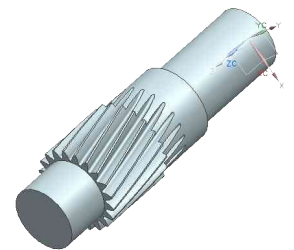

Virtual Workshops

1. Basics, Design & Optimization of Cylindrical Gears

This seminar presents the essential fundamentals and explores the basics of cylindrical gears. The workshop covers the key aspects that all engineers need to know about cylindrical gears. This course also provides in-depth knowledge and skills in the dimensioning and optimizing of cylindrical gears. The attendees will dive to more advanced in-depth, technical issues. Together with the basics of cylindrical gears, the participants can gain access to a considerable amount of useful information. The software products eAssistant and TBK 2014 are used in order to illustrate certain principles. This seminar is designed for young professionals, experienced engineers, designers as well as technicians and for all those who want to refresh their knowledge.

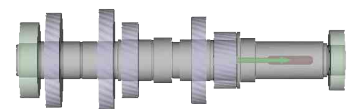

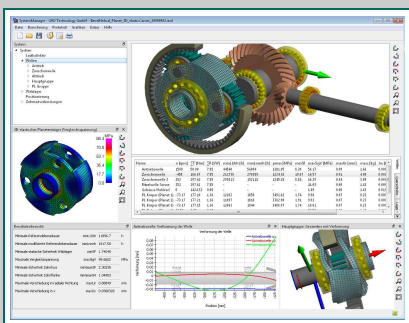
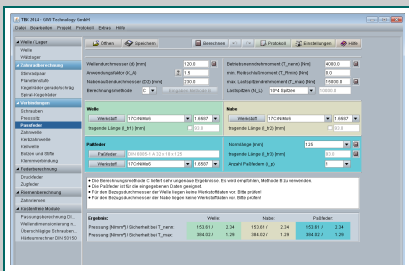
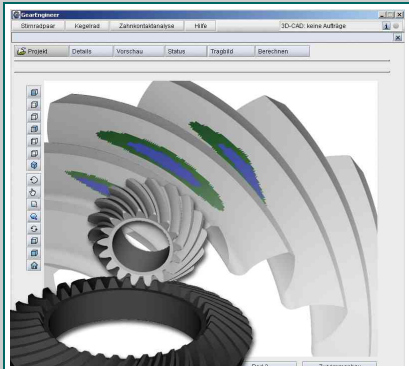
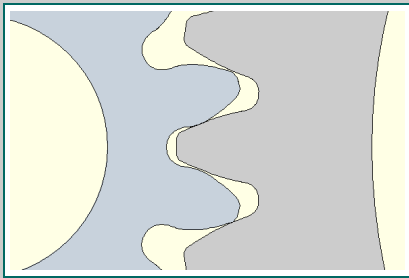

2. Kegelräder

This seminar provides an understanding of the essential fundamentals of bevel gears. The main focus will be on different types of bevel gears, manufacturing procedures as well as the basics of bevel gear calculation. Seminar participants take a closer look at spiral bevel gears (Klingenberg's Zyklo-Palloid®). GearEngine, eAssistant and TBK 2014 software are used to illustrate certain principles. Intended audience include young professionals, experienced engineers, designers as well as technicians.

3. SystemManager – Basics

This workshop focuses on the "SystemManager" software and covers the basic information needed to start using this software application, such as the basic handling and the possibilities the software offers. No special prior knowing is required. The seminar is for young professionals, experienced engineers, designers and technicians and is the perfect basis for the advanced course "SystemManager – In Depth".

4. SystemManager – In Depth

This seminar is the ideal complement to the "SystemManager – Basics" workshop. After the theoretical basics, the course allows a deeper dive into the software, using practical examples. This course is recommended only for advanced users who have prior knowledge of the SystemManager software.

5. Shaft-Hub Connections



This seminar is about the design, re-calculation and optimisation of shaft-hub connections, such as interference fits, parallel keys, involute splines or clamping connections, in conjunction with the software applications eAssistant/TBK 2014. With useful tips and instructions, the participants get the chance to better understand the theory. The seminar is suitable for young professionals, experienced engineers, designers and technicians.

6. Shafts and Bearings



This seminar has a main focus on shafts and bearings. eAssistant and TBK 2014 are used to illustrate terms and principles. General settings, configuration and calculation options are discussed. This course is packed with many practical examples. No special prior knowledge is required. This course is for young professionals, experienced engineers, designers as well as technicians.

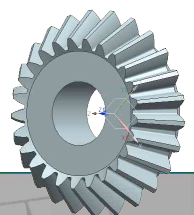

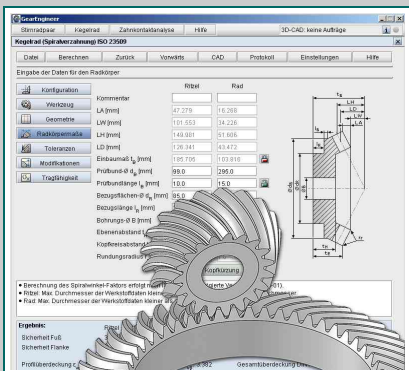
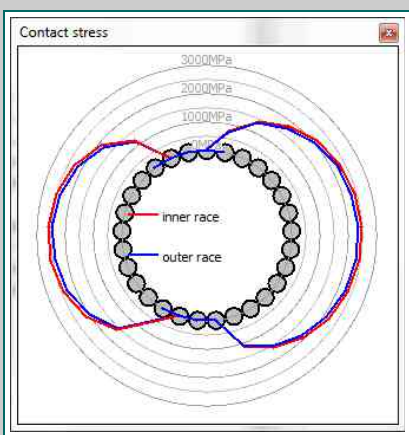
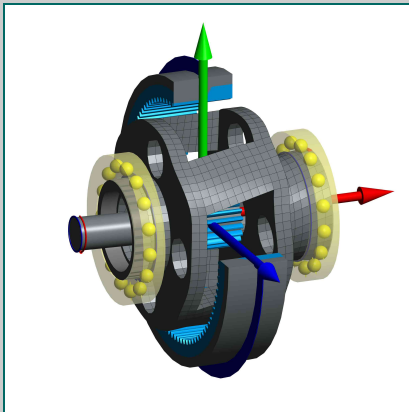

7. Bolted Joints

In this seminar, the participants gain in-depth insights into the bolt calculation according to VDI 2230. It starts with the general basics of bolts, followed by an introduction to VDI 2230, all with extensive examples. eAssistant and TBK 2014 are used. This seminar is designed for young professionals, experienced engineers, designers as well as technicians.



General Information

This year we combine live, in-person elements with digital, online components. All workshops will take place over video conference and you can interact live with the trainer and attendees, as if you were physically in the classroom.

The courses are divided into three or two blocks of **two hours** each. Date and time are set individually.

These prices are indicated in EURO. All prices are strictly net and exclusive of value added tax. The workshop price includes all the study material and every attendee will receive a certificate.

The aim of the workshop is to have an extensive exchange of know-how and experience, to resolve technical problems and to share design strategies – a good mix of examples, learning and experience.

Are you looking for a workshop that is exactly tailored to your needs? We would be happy to design a tailor-made exclusive seminar for your company. The content and date of these individual workshops will be coordinated in advance to suit your exact needs.

If you need further information, please do not hesitate to contact us.